

Pressure sensors

Ex ia I / IIC T6 acc. to ATEX

with internal diaphragm

with front flush diaphragm

Accuracy: 0,25% and 0,5 %

Standard output: 4...20 mA; 2-wire system



Description

- pressure sensors Industrial Heavy Duty are top of the range products in Ex - pressure gauge technology.

The intrinsically safe Ex - pressure sensors are designed for zone 1 (optional mount on Zone 0) and have special type approval for use in potentially explosive atmospheres and a CENELEC certificate according to the ATEX certification.

The measuring ranges, graded in accordance with EN, range from 100 mbar to the maximum pressure range of 1000 bar. The case and wetted parts comprise stainless steel and are thus resistant to chemically aggressive media. The pressure connection and measuring element are welded together, making the measuring system particularly resistant to mechanical shock or vibration.

The pressure connection is fitted with a G ½ male thread. Several electrical connections can be obtained to pick up the electrical output signal.

The front flush pressure diaphragm avoids zones, in which medium could crystallize or residues could form

The field case design enables use in aggravated operation conditions.

The Ex - pressure sensors Industrial Heavy Duty meet the electronic magnetic compatibility (EMC) requirements to EN 61326.

Features

- intrinsically safe, zone 1
- option: build to zone 0
- high long-term stability
- high accuracy
- finely graded selection of nominal pressure ranges according to EN
- corrosion resistant stainless steel design
- good repeatability
- high overload protection
- for dynamic and static measurements
- simple installation
- ATEX certificate

Measuring ranges

High pressure

Negative	-1...0 bar	to	-0,1...0 bar
Positive	0...0,1 bar	to	0... 1000 bar
Absolute pressure	0...0,25 bar	to	0... 16 bar

Applications

Chemical and pharmaceutical industry,
food industry and environmental technology,
process engineering.

Model: PEX10, PEX11, PEX13, PEX14

Technical data

Model	PEX10	PEX11	PEX13	PEX14
Type	Standard with internal diaphragm	Standard with front flush diaphragm	Field case with internal diaphragm	Field case with front flush diaphragm
Pressure type	negative / positive / high pressure absolute pressure ³⁾			
Output signal	4...20 mA - 2- wire system			
Accuracy % of F.S. ¹⁾	0,5 (option 0,25 BFSL) 0,25 (option 0,125 BFSL) ²⁾			
Measuring ranges acc. to EN ²⁾	0 ... 0,1 bar ²⁾ to 0 ... 1000 bar	0 ... 0,1 bar to 0 ... 600 bar	0 ... 0,1 bar to 0 ... 1000 bar	0 ... 0,1 bar to 0 ... 600 bar
Repeatability	≤ ± 0,05 % of F.S.			
Stability (annual)	≤ ± 0,2 % of F.S. in rated conditions			
Case	stainless steel 1.4571			
Process connection	G ½ B acc. EN 837 option: G ¼ B, ½ NPT, ¼ NPT	to 1,6 bar G 1 B; from 2,5 bar G ½ B ¼ NPT	G ½ B acc. EN 837	to 1,6 bar G 1 B; from 2,5 bar G ½ B
Wetted parts	stainless steel	stainless steel, NBR option Hastelloy C4	stainless steel	stainless steel option Hastelloy C4
O-ring		option FPM, EPDM		option FPM, EPDM
Overload limit	≤ 16 bar 3,5-fold; ≤ 600 bar 2-fold; > 600 bar 1,5-fold; vacuum proof			
Electr. connection and protection type acc. to EN 60 529/IEC529	plug acc. to DIN EN 175301 - 803 A with junction box (PG 9), IP 65 option: plug acc. to DIN EN 175301- 803 A with junction box (PG13,5), IP 65 for ship approval) round connector 4-pin M12x1, IP 67 MIL-plug 6-pin round connector M 16x0,75 5-pin cable outlet IP 67 with 1,5 m cable with inner ventilation cable outlet IP 68 with 1,5 m cable with inner ventilation (zero / span adjustable) cable outlet IP 68 with 1,5 m cable with inner ventilation (zero / span not adjustable)			
Power supply	10 ... 30 VDC (field case 11... 30 VDC)			
Power consumption	signal current			
Power PI	1W (750 mW with approval for Category 1D)			
Load standard	$R_A[\Omega] \leq (U_B[V]-10V)/0,02A - (0,14[\Omega] \times \text{cable length in [m] })$			
Load field case	$R_A[\Omega] \leq (U_B[V]-11V)/0,02A$			
Test circuit signal	$R_A[\Omega] < 15 \text{ max. load}$			
Temperature comp. Range	0... 80 °C			
Temperature influence ⁴⁾	≤ 0,2 % /10 K on zero and span			
Adjustability	Zero and span up to ± 10%			
Response time	≤ 1 ms (within 10 % to 90 % of. F.S.)			
Protection type	IP 65 acc. to EN 60 529/IEC 529			
CE-certification	89/336/EWG, interference emission and immunity see EN 61326, interference emission limit class A and B, ATEX EN 50014 (general part), EN 50 020 (intrinsic safety), EN 50 284 (Zone 0), EN 50 281-1 (dust-Ex), EN 50303 (mining industry)			
HF immunity	10 V/m			
Burst	2 KV			
Electrical protection types	reverse polarity protection			
Explosion proof protection type ATEX	EEx ia I / IIC T4-T6 (BVS 08 ATEX E 067 X) ⁵⁾ category 1G, 1/2G, 2G , 1D, 1/2D, 2D, M1, M2			
Temperature ranges				
- storage	-30 ... 105 °C			
- media	-20... 80 °C ⁶⁾			
- ambient	-20 ...80 °C ⁶⁾			
Weight	ca. 0,2 kg			

of.F.S.= of Full Scale

- 1) Terminal point adjustment according to DIN 16 086, including non-linearity and hysteresis, zero point and full scale deviation
- 2) 0,25% accuracy only for ranges ≥ 0,25 bar
- 3) Absolute pressure from 0,25 bar to 16 bar
- 4) Tk zero point < 0,4 % /10 K; for measuring ranges 0...0,1 and 0...0,16 bar
- 5) Application conditions and safety data see listing acc. to EC Type Test certificate (BVS 08 ATEX E 067 X)
- 6) Other temperature range, see listing acc. to EC Type Test certificate

Dimensions (mm)

Case

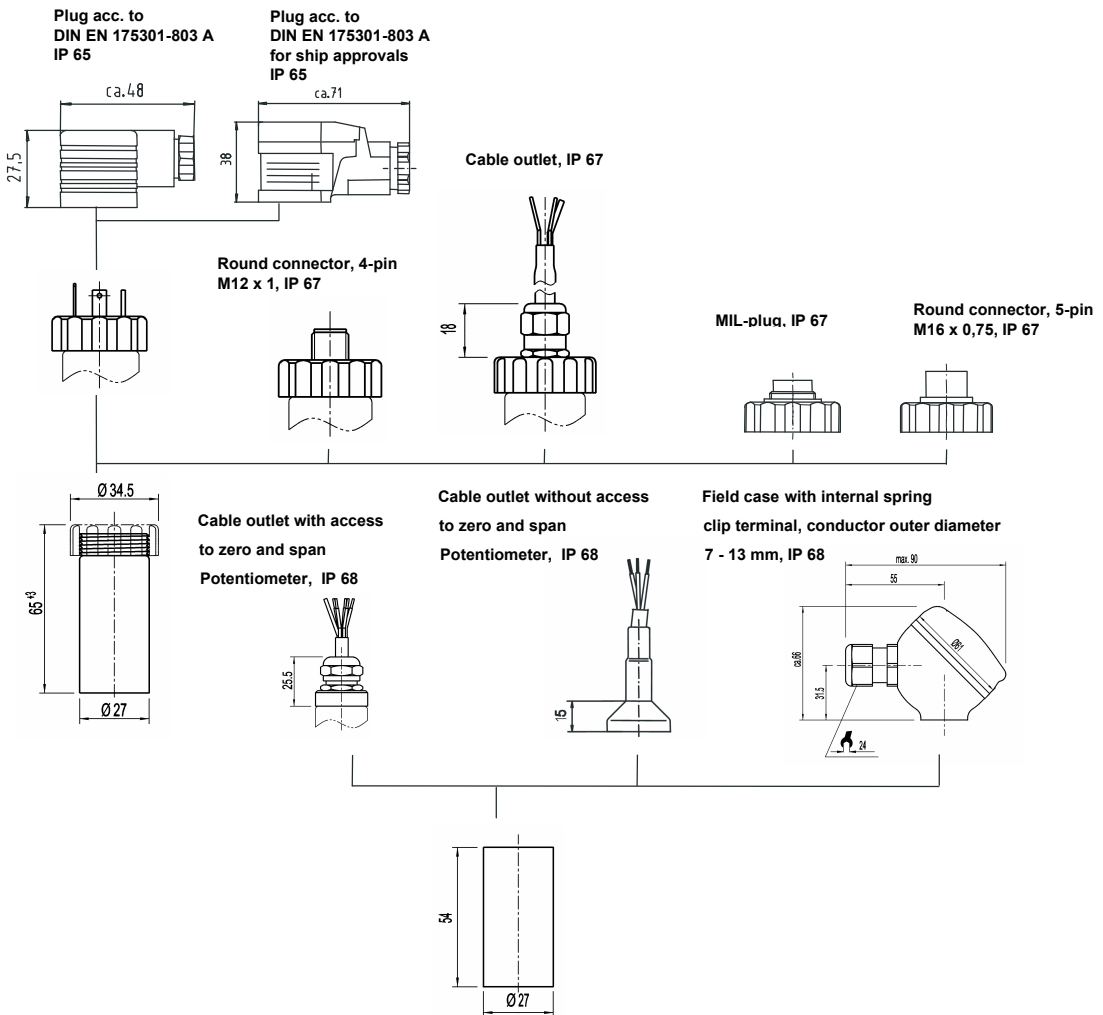

Pressure connection internal diaphragm

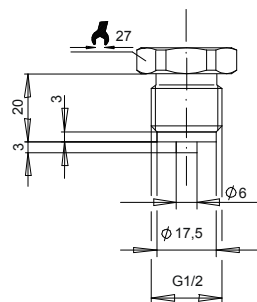

Pressure connection front flush diaphragm

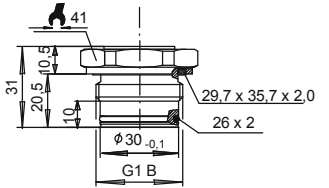
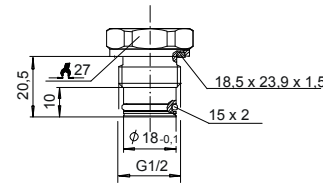
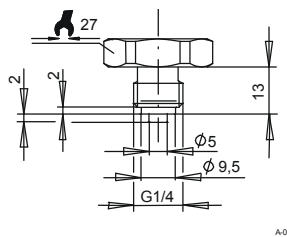

Screw-in aperture internal diaphragm

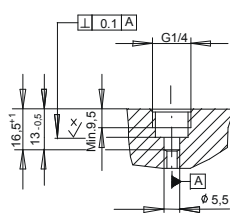
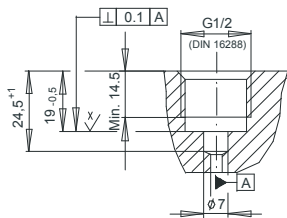

Weld-on adapter front flush diaphragm

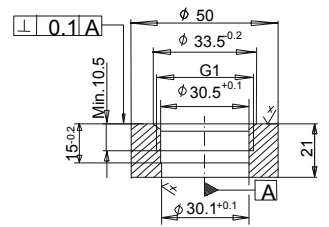
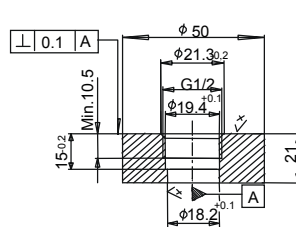

Electrical connection

Two-wire system

Plug to DIN 43 650

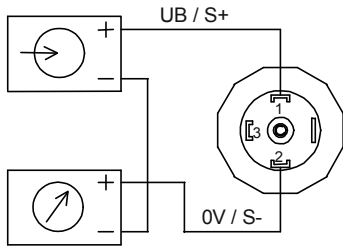

E-001

Cable outlet

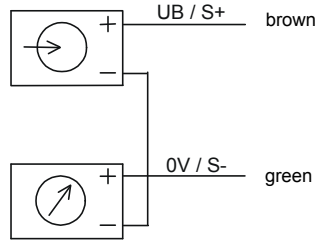

E-015

Field case

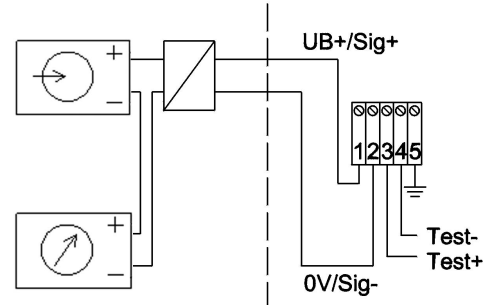

Mil-plug PT 02 E-10-6P

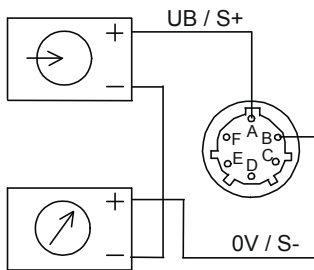

4-pin round connector M 12 x 1

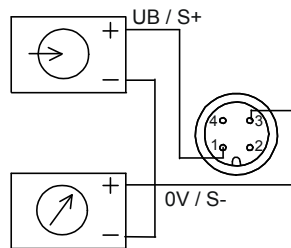

E-033

5-pin round connector M 16 x 0,75

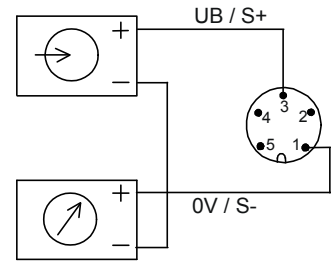

Ex-Zone (in comparison ATEX and CSA)

	Flammable material Present continuously	Flammable material Present intermittently	Flammable material Normally not present
ATEX	Zone 0 (Zone 20 dust)	Zone 1 (Zone 21 dust)	Zone 2 (Zone 22 dust)
CSA	Zone 0	Zone 1	Zone 2
	Division 1		Division 2

		ATEX Group	CSA Class	Group
Above ground	Gases and vapours	IIA / IIB / IIC	I	A / B / C / D / E / F / G
	Dusts		II	
	Fibres		III	

Other details

1. Model
2. Measuring range
3. Options
4. **Ex-Zone**

Modifications reserved