

Pressure gauges with switch contacts in stainless steel housing

Nominal sizes NG 40 and 50

Central connection on the back,
radial connection on the bottom



Description

The pressure gauges with electrical limit contacts in the model series S4634 and S4635 are suitable for controlling or regulating process flow. They have one or two switching outputs.

Only one single device and connection is needed for the switching operation and to monitor pressure. Set-point adjustment is carried out in the pressure-less state. As a result, complex adjustment in several pressure cycles is dispensed with.

Our contact pressure gauges comply with the general international metrological recommendations and take into account the application and standard-related requirements set forth by EN 837-1.

Features

- Connections available on the bottom and the back
- Outstanding switching reliability and long service life
- Magnetic spring contact and gold-plated contact lug
- Designed in accordance with EN 837-1
- Pressure display over 270°
- Adjustable contact between 10% and 90% of the display range

Display ranges

NG 40: 0 - 2.5 to 0 - 400 bar

NG 50: 0 - 0,6 to 0 - 400 bar

and all of the relevant ranges for negative or negative and positive overpressure

Applications

- Display and monitoring of container pressure in gas extinguishing systems in accordance with EN 12094-10 (VdS/CE)
- Signalling leaks in containers
- Water dispensing
- Welding technology
- Medical engineering

Model: S4634, S4635

Technical data

Model	S4634	S4635
Nominal size	40	50
Configuration	Positive overpressure, negative overpressure, positive and negative overpressure	
Process connection	Standard Central back G1/8 B G1/4 B Optional Radial bottom Others on request G1/8 B	
Measuring principle	≤ 60 bar bourdon tube C-type; >60 bar bourdon tube helical type	
Ranges	0 - 2.5 to 0 - 400 bar	0 - 0.6 to 0 - 400 bar
Accuracy class	CL. 2.5 Optional CL. 1.6	
Usage areas	Constant load Alternating load Short-time load 3/4 x Full scale value 2/3 x Full scale value Full scale value	
Materials	Housing Window Dial Pointer Movement/Measuring elem. Process connection Stainless steel Plastic Aluminium, white Plastic, black brass brass	
Switching outputs	Number Optional Switching function Switching element Repeatability Adjustment Standard Optional 1 2 NO or NC Magnet snap action contact max. ± 2.5% of full scale value. In site Factory adjusted	
Power rating	Switching voltage Switching current Contact load 4.5 - 24 VDC/VAC 5 - 100 mA max. 2.4 W	
Temperature ranges	Media Ambient effect* +60 °C maximal -40 to +60 °C max. ±0.4 %/10 K of full scale	
Electrical connection	Cable output Optional Plug	
Protection type	IP54 acc. EN 60529 / IEC 529 Optional IP65 (Dimensions on request)	
Leakage rate	$10 \times 10^{-5} \frac{\text{mbar} \cdot \text{xl}}{\text{s}}$ (Helium-Leakage test)	
Weight	0.10 kg	0.12 kg
Accessories optional	Orifice 0.3mm	

* when temperature of the measuring system deviates from reference temperature (+20°C)

Dimensions (in mm)

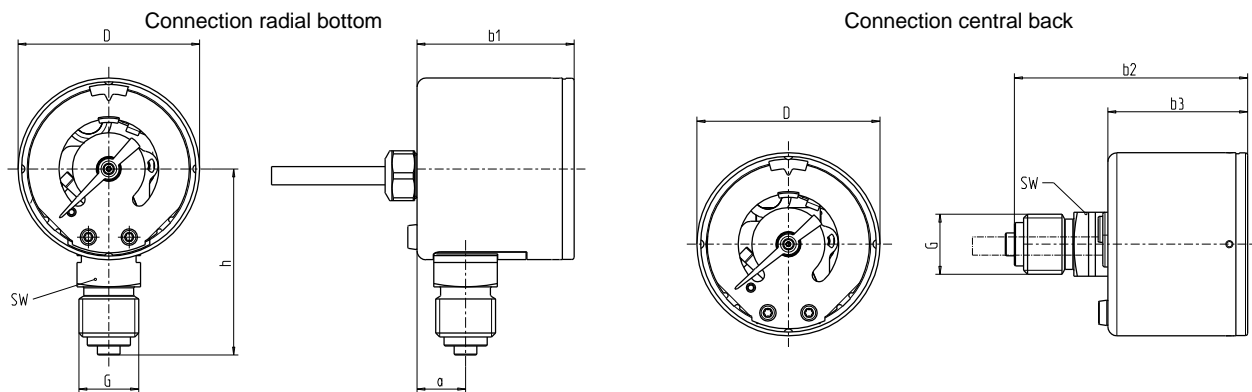

Model	a	b1 ± 0.5	b2 ± 1	SW
S4634, S4635 (1 switching output)	11	30.5	48	14
S4635 (2 switching outputs)	11	41	59.4	14

Subject to technical alternations